

SAMSUNG

USER MANUAL

HW-R650









SAFETY INFORMATION

SAFETY WARNINGS

TO REDUCE THE RISK OF ELECTRIC SHOCK, DO NOT REMOVE THE COVER (OR BACK).

NO USER-SERVICEABLE PARTS ARE INSIDE. REFER SERVICING TO QUALIFIED SERVICE PERSONNEL.

Refer to the table below for an explanation of symbols which may be on your Samsung product.

	<p style="text-align: center;">CAUTION RISK OF ELECTRIC SHOCK. DO NOT OPEN.</p>	
	<p>This symbol indicates that high voltage is present inside. It is dangerous to make any kind of contact with any internal part of this product.</p>	
	<p>This symbol indicates that this product has included important literature concerning operation and maintenance.</p>	
	<p>Class II product : This symbol indicates that it does not require a safety connection to electrical earth (ground). If this symbol is not present on a product with a power cord, the product MUST have a reliable connection to protective earth (ground).</p>	
	<p>AC voltage : This symbol indicates that the rated voltage marked with the symbol is AC voltage.</p>	
	<p>DC voltage : This symbol indicates that the rated voltage marked with the symbol is DC voltage.</p>	
	<p>Caution, Consult instructions for use : This symbol instructs the user to consult the user manual for further safety related information.</p>	

WARNING

- To reduce the risk of fire or electric shock, do not expose this appliance to rain or moisture.

CAUTION

- TO PREVENT ELECTRIC SHOCK, MATCH WIDE BLADE OF PLUG TO WIDE SLOT, FULLY INSERT.
- This apparatus shall always be connected to a AC outlet with a protective grounding connection.
- To disconnect the apparatus from the mains, the plug must be pulled out from the mains socket, therefore the mains plug shall be readily operable.
- Do not expose this apparatus to dripping or splashing. Do not put objects filled with liquids, such as vases on the apparatus.
- To turn this apparatus off completely, you must pull the power plug out of the wall socket. Consequently, the power plug must be easily and readily accessible at all times.

PRECAUTIONS

1. Ensure that the AC power supply in your house complies with the power requirements listed on the identification sticker located on the bottom of your product. Install your product horizontally, on a suitable base (furniture), with enough space around it for ventilation (7~10 cm). Make sure the ventilation slots are not covered. Do not place the unit on amplifiers or other equipment which may become hot. This unit is designed for continuous use. To fully turn off the unit, disconnect the AC plug from the wall outlet. Unplug the unit if you intend to leave it unused for a long period of time.
2. During thunderstorms, disconnect the AC plug from the wall outlet. Voltage peaks due to lightning could damage the unit.
3. Do not expose the unit to direct sunlight or other heat sources. This could lead to overheating and cause the unit to malfunction.
4. Protect the product from moisture (i.e. vases), and excess heat (e.g. a fireplace) or equipment creating strong magnetic or electric fields. Unplug the power cable from the AC wall socket if the unit malfunctions. Your product is not intended for industrial use. It is for personal use only. Condensation may occur if your product has been stored in cold temperatures. If transporting the unit during the winter, wait approximately 2 hours until the unit has reached room temperature before using.

5. The battery used with this product contains chemicals that are harmful to the environment. Do not dispose of the battery in the general household trash. Do not expose the battery to excess heat, direct sunlight, or fire. Do not short circuit, disassemble, or overheat the battery. Danger of explosion if the battery is replaced incorrectly. Replace only with the same or equivalent type.

ABOUT THIS MANUAL

The user manual has two parts: this simple paper USER MANUAL and a detailed FULL MANUAL you can download.



USER MANUAL

See this manual for safety instructions, product installation, components, connections, and product specifications.



FULL MANUAL

You can access the FULL MANUAL on Samsung's on-line customer support centre by scanning the QR code. To see the manual on your PC or mobile device, download the manual in document format from Samsung's website. (<http://www.samsung.com/support>)

Design and specifications are subject to change without prior notice.

CONTENTS

01	Checking the Components	2
	Inserting Batteries before using the Remote Control (AA batteries X 2)	2
02	Product Overview	3
	Front Panel / Right Side Panel of the Soundbar	3
	Bottom Panel of the Soundbar	3
03	Connecting the Soundbar	4
	Connecting Electrical Power	4
	Connecting the Soundbar to the Subwoofer	5
	– Automatic connection between the Subwoofer and the Soundbar	5
	– Manually connecting the Subwoofer if automatic connection fails	6
	Connecting an SWA-8500S (Sold Separately) to your Soundbar	7
04	Connecting to your TV	9
	Method 1. Connecting with a Cable	9
	– Connecting using an Optical Cable	9
	– Connecting a TV using an HDMI Cable	10
	Method 2. Connecting Wirelessly	11
	– Connecting a TV via Bluetooth	11
05	Connecting an External Device	13
	Connecting using an Optical or Analogue Audio (AUX) Cable	13
	Connecting using an HDMI Cable	14
06	Connecting a USB Storage Device	15
	Software Update	15

07	Connecting a Mobile Device	16
	Connecting via Bluetooth	16
08	Using the Remote Control	17
	How to Use the Remote Control	17
	Adjusting the Soundbar volume with a TV remote control	20
09	Installing the Wall Mount	21
	Installation Precautions	21
	Wallmount Components	21
10	Troubleshooting	24
11	Licence	25
12	Open Source Licence Notice	25
13	Important Notes About Service	25
14	Specifications and Guide	26
	Specifications	26

01 CHECKING THE COMPONENTS

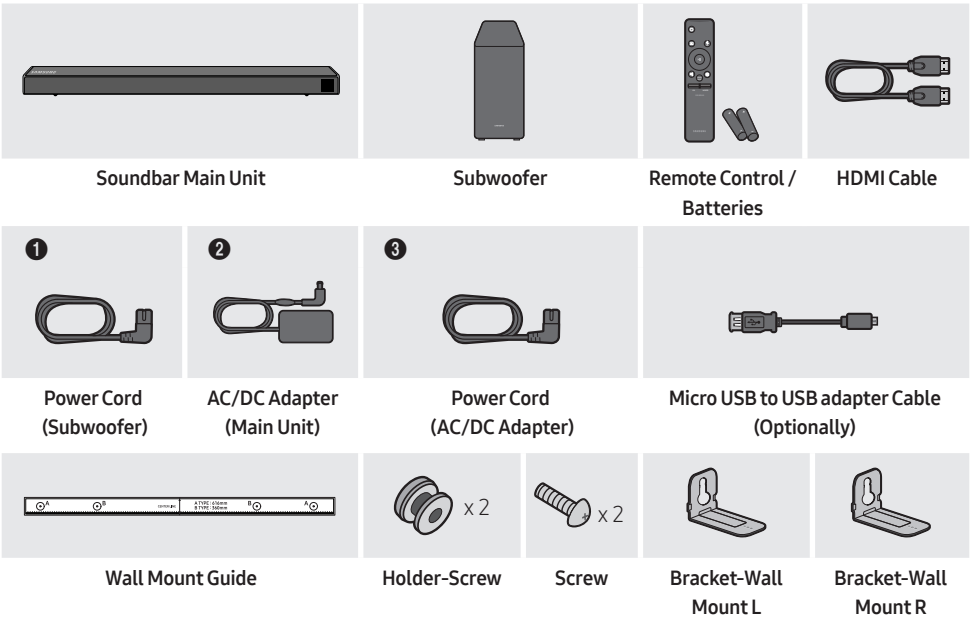

- For more information about the power supply and power consumption, refer to the label attached to the product. (Label: Bottom of the Soundbar Main Unit)
- The power components are labelled (1, 2, 3). For more information about power connections, see page 4.
- To purchase additional components or optional cables, contact a Samsung Service Centre or Samsung Customer Care.
- Depending on the region, the appearance of the AC plug may differ from the plug displayed above, or it may be supplied integrated with the AC/DC adapter.
- The appearance of the accessories may differ slightly from the illustrations above.

Inserting Batteries before using the Remote Control (AA batteries X 2)

Slide the battery cover in the direction of the arrow until it is completely removed. Insert 2 AA batteries (1.5V) oriented so that their polarity is correct. Slide the battery cover back into position.

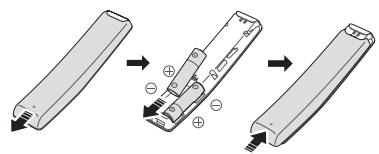

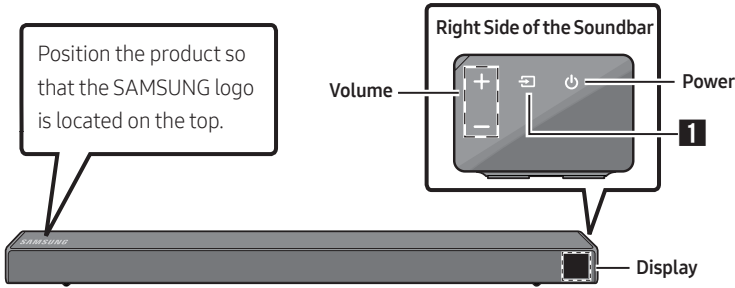

02 PRODUCT OVERVIEW

Front Panel / Right Side Panel of the Soundbar

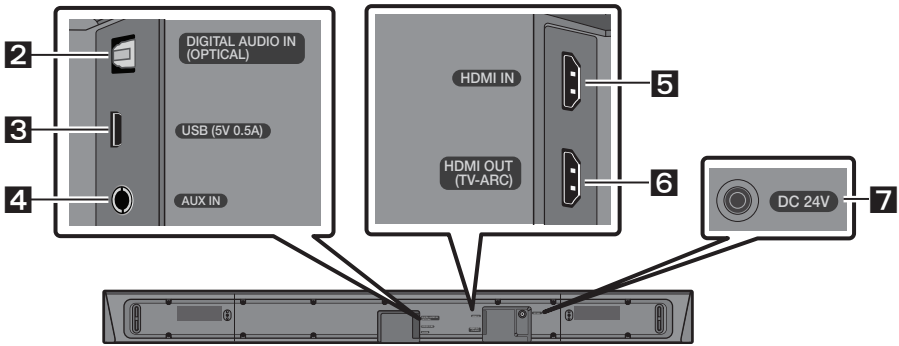

Bottom Panel of the Soundbar



1	Source	Selects the source input mode. (D.IN / AUX / HDMI / BT / USB) <ul style="list-style-type: none"> To turn on "BT PAIRING" mode, change the source to "BT" mode, and then press and hold the  (Source) button for more than 5 seconds.
2	D.IN	Connect to the digital (optical) output of an external device.
3	USB	Connect a USB device here to play music files on the USB device through the Soundbar.
4	AUX	Connect to the Analogue output of an external device.
5	HDMI IN	Inputs digital video and audio signals simultaneously using an HDMI cable. Connect to the HDMI output of an external device.
6	HDMI OUT	Connect to the HDMI (ARC) jack on a TV.
7	DC 24V	Connect the AC/DC power adapter. (Power Supply In)

03 CONNECTING THE SOUNDBAR

Connecting Electrical Power

Use the power components (1, 2, 3) to connect the Subwoofer and Soundbar to an electrical outlet in the following order:

- 1 Connect the power cord to the Subwoofer.
- 2 Connect the power output cable to the power adapter, and then to the Soundbar.
- 3 Connect the power cord to a wall socket.

See the illustrations below.

- For more information about the required electrical power and power consumption, refer to the label attached to the product. (Label: Bottom of the Soundbar Main Unit)

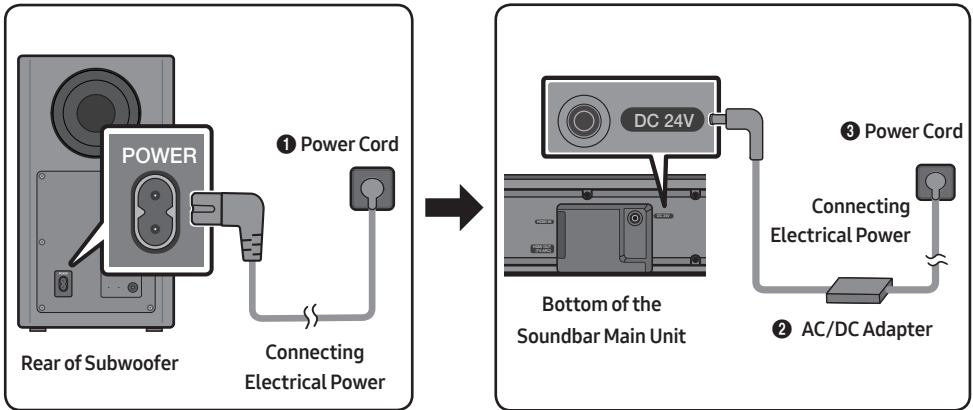

- Make sure to rest the AC/DC Adapter flat on a table or the floor. If you place the AC/DC Adapter so that it is hanging with the AC cord input facing upwards, water or other foreign substances could enter the Adapter and cause the Adapter to malfunction.

Connecting the Soundbar to the Subwoofer

When the subwoofer is connected, you can enjoy rich bass sound.

Automatic connection between the Subwoofer and the Soundbar

When you turn the power on after connecting the power cables to the Soundbar and subwoofer, the subwoofer is automatically connected to the Soundbar.

- When auto pairing is complete, the blue indicators at the rear of the subwoofer turn on.

LED Indicator Lights on the Rear of Subwoofer

LED	Status	Description	Resolution
Blue	On	Successfully connected (normal operation)	-
	Blinking	Recovering the connection	Check if the power cable attached to the main Soundbar unit is connected properly or wait about 5 minutes. If blinking persists, try manually connecting the subwoofer. See page 6.
Red	On	Standby (with the Soundbar main unit turned off)	Check if the power cable attached to the main Soundbar unit is connected properly.
		Connection failed	Connect again. See the instructions for manual connection on page 6.
Red and blue	Blinking	Malfunction	See the contact information for the Samsung Service Centre in this manual.

Manually connecting the Subwoofer if automatic connection fails

Before performing the manual connection procedure below:

- Check whether the power cables for the Soundbar and subwoofer are connected properly.
- Make sure that the Soundbar is turned on.

1. Press and hold **ID SET** on the rear of the subwoofer for at least 5 seconds.
 - The red indicator on the rear of the subwoofer turns off and the blue indicator blinks.

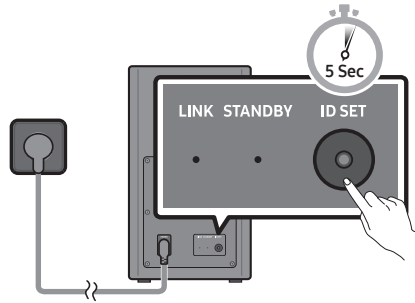

Rear of Subwoofer

2. Press and hold the **Up** button on the remote control for at least 5 seconds.
 - The **ID SET** message appears on the display of the Soundbar for a moment, and then it disappears.
 - The Soundbar will automatically power on when **ID SET** is complete.

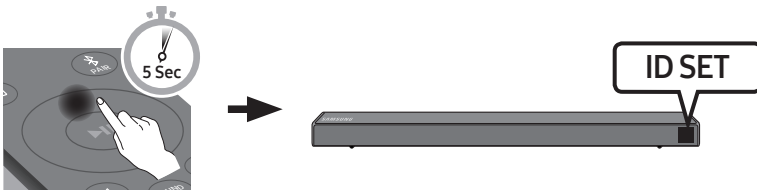

3. Check if the LINK LED is solid blue (connection complete).

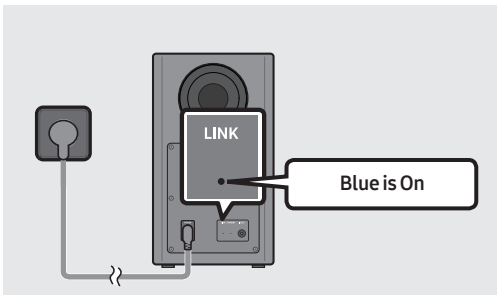

The LINK LED indicator stops blinking and glows a solid blue when a connection is established between the Soundbar and the Wireless Subwoofer.

Connecting an SWA-8500S (Sold Separately) to your Soundbar

Expand to true wireless surround sound by connecting the Samsung Wireless Rear Speaker Kit (SWA-8500S, sold separately) to your Soundbar.

1. Connect the Wireless Receiver Module to 2 Surround Speakers.
 - The speaker cables are colour coded.

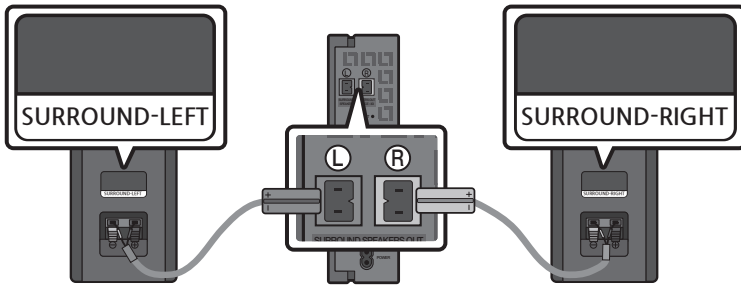

2. Check the standby status of the Wireless Receiver Module after plugging it into an electrical outlet.
 - The LINK LED indicator (blue LED) on the Wireless Receiver Module blinks. If the LED does not blink, press the **ID SET** button on the back of the Wireless Receiver Module with a pen tip for 5~6 seconds until the LINK LED indicator blinks (in Blue). For more about the LED, please refer to the SWA-8500S user manual.

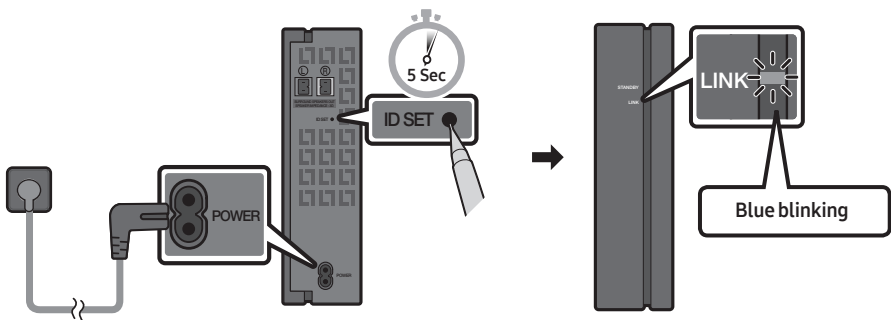

3. Press and hold the **Up** button on the remote control for at least 5 seconds.
 - The **ID SET** message appears on the display of the Soundbar for a moment, and then it disappears.
 - The Soundbar will automatically power on when **ID SET** is complete.

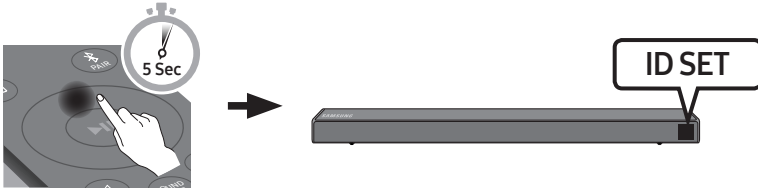

⚠ CAUTION

- If your Soundbar was playing music when it connects to the SWA-8500S, you may hear some stuttering from the woofer as the connection finalises.

4. Check if the LINK LED is solid blue (connection complete).

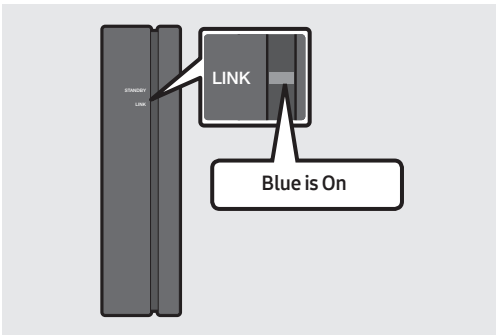

The LINK LED indicator stops blinking and glows a solid blue when a connection is established between the Soundbar and the Wireless Receiver Module.

5. If the SWA-8500S is not connected, repeat the procedure from Step 2.

04 CONNECTING TO YOUR TV

Hear TV sound from your Soundbar through wired or wireless connections.

- When the Soundbar is connected to selected Samsung TVs, the Soundbar can be controlled using the TV's remote control.
 - This feature is supported by 2017 and later Samsung Smart TVs that support Bluetooth when you connect the Soundbar to the TV using an optical cable.
 - This function also allows you to use the TV menu to adjust the sound field and various settings as well as the volume and mute.

Method 1. Connecting with a Cable

When the audio in a broadcast is encoded in Dolby Digital and the “Digital Output Audio Format” on your TV is set to PCM, we recommend that you change the setting to Dolby Digital. When the setting on the TV is changed, you will experience better sound quality. (The TV menu may use different words for Dolby Digital and PCM depending on the TV manufacturer.)

Connecting a TV using an HDMI Cable

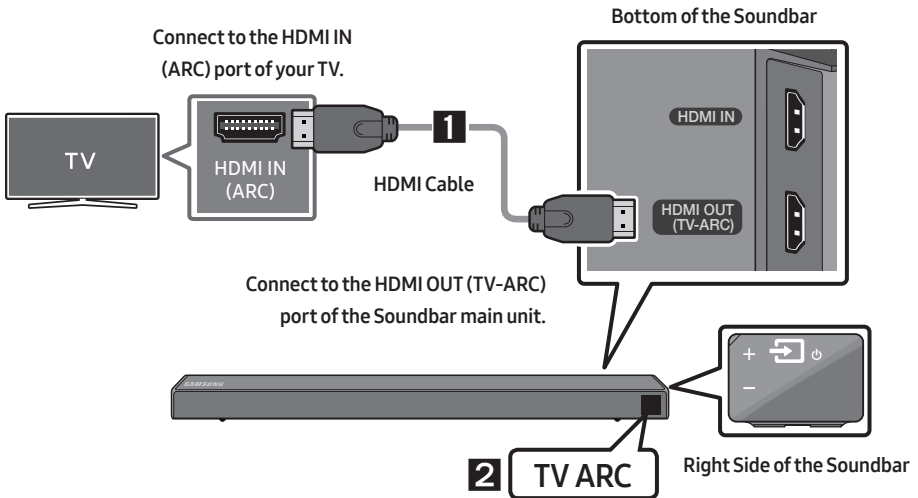

1. With the Soundbar and TV turned on, connect the HDMI cable as shown in the figure.
2. “TV ARC” appears in the display window of the Soundbar main unit and the Soundbar plays TV sound.
 - If TV sound is inaudible, press the  (**Source**) button on the remote control or on the right side of the Soundbar to switch to “D.IN” mode. The screen displays “D.IN” and “TV ARC” in sequence, and TV sound is played.

- If “TV ARC” does not appear in the display window of the Soundbar main unit, confirm that the HDMI cable is connected to the correct port.
- Use the volume buttons on the TV’s remote control to change the volume on the Soundbar.

Connecting using an Optical Cable

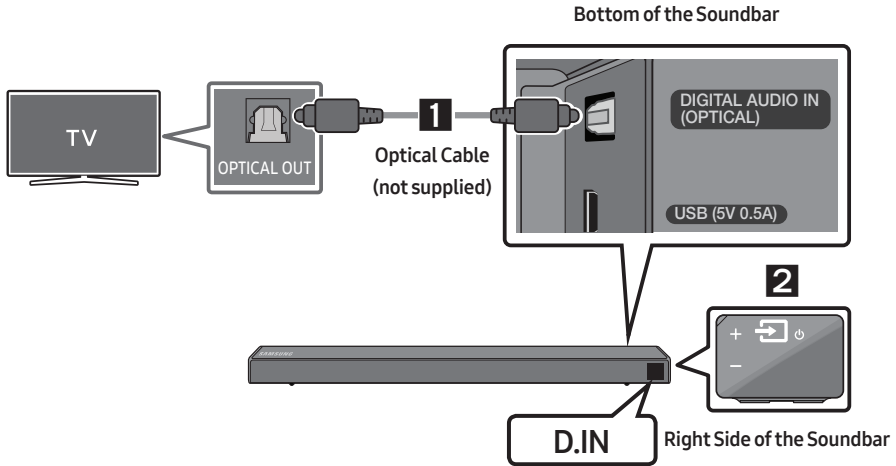

1. Connect the **DIGITAL AUDIO IN (OPTICAL)** jack on the Soundbar to the **OPTICAL OUT** jack of the TV with a digital optical cable (not supplied).
2. Press the  (**Source**) button on the right side panel or remote control, and then select the “**D.IN**” mode.

Auto Power Link

Auto Power Link automatically turns on the Soundbar when the TV is turned on.

1. Connect the Soundbar and a TV with a digital optical cable (not supplied).
2. Press the **Left** button on the remote control for 5 seconds to turn Auto Power Link on or off.
 - Auto Power Link is set to ON by default.
(To turn off this function, hold the **Left** button on the remote for 5 seconds.)
 - Depending on the connected device, Auto Power Link may not function.
 - This function is only available in the “**D.IN**” mode.



Method 2. Connecting Wirelessly

Connecting a TV via Bluetooth

When a TV is connected using Bluetooth, you can hear stereo sound without the hassle of cabling.

- Only one TV can be connected at a time.

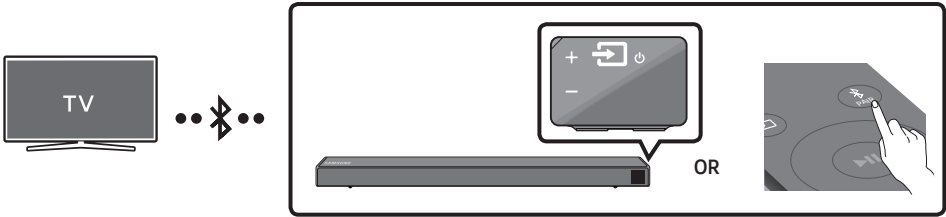

The initial connection

1. Press the **PAIR** button on the remote control to enter the “**BT PAIRING**” mode.
- (OR)
 - a. Press the **Source** button on the right side panel and then select “**BT**”.
“**BT**” changes to “**BT READY**” in a few seconds automatically if there is no Bluetooth device connected to the Soundbar.
 - b. When “**BT READY**” appears, press and hold the **Source** button on the right side panel of the Soundbar for more than 5 seconds to display “**BT PAIRING**”.
2. Select Bluetooth mode on the TV. (For more information, see the TV’s manual.)
3. Select “[AV] Samsung Soundbar R6-Series” from the list on TV’s screen.
An available Soundbar is indicated with “**Need Pairing**” or “**Paired**” on the TV’s Bluetooth device list. To connect the TV to the Soundbar, select the message, and then establish a connection.
 - When the TV is connected, [TV Name] → “**BT**” appears on the Soundbar’s front display.
4. You can now hear TV sound from the Soundbar.

If the device fails to connect



- If a previously connected Soundbar listing (e.g. “[AV] Samsung Soundbar R6-Series”) appears in the list, delete it.
- Then repeat steps 1 through 3.

Disconnecting the Soundbar from the TV

Press the  (**Source**) button on the right side panel or on the remote control and switch to any mode but "BT".

- Disconnecting takes time because the TV must receive a response from the Soundbar. (The time required may differ, depending on the TV model.)
- To cancel the automatic Bluetooth connection between the Soundbar and TV, press the **▶|| (Play/Pause)** button on the remote control for 5 seconds with the Soundbar in "BT READY" status. (Toggle On → Off)

What is the difference between BT READY and BT PAIRING?

- **BT READY** : In this mode, you can search for previously connected TVs or connect a previously connected mobile device to the Soundbar.
- **BT PAIRING** : In this mode, you can connect a new device to the Soundbar. (Press the  **PAIR** button on the remote control or press and hold the  (**Source**) button on the right side of the Soundbar for more than 5 seconds while the Soundbar is in "BT" mode.)

NOTES

- If asked for a PIN code when connecting a Bluetooth device, enter <0000>.
- In Bluetooth connection mode, the Bluetooth connection will be lost if the distance between the Soundbar and the Bluetooth device exceeds 10 meters.
- The Soundbar automatically turns off after 20 minutes in the Ready state.
- The Soundbar may not perform Bluetooth search or connection correctly under the following circumstances:
 - If there is a strong electrical field around the Soundbar.
 - If several Bluetooth devices are simultaneously paired with the Soundbar.
 - If the Bluetooth device is turned off, not in place, or malfunctions.
- Electronic devices may cause radio interference. Devices that generate electromagnetic waves must be kept away from the Soundbar main unit - e.g., microwaves, wireless LAN devices, etc.

05 CONNECTING AN EXTERNAL DEVICE

Connect to an external device via a wired or wireless network to play the external device's sound through the Soundbar.

Connecting using an HDMI Cable

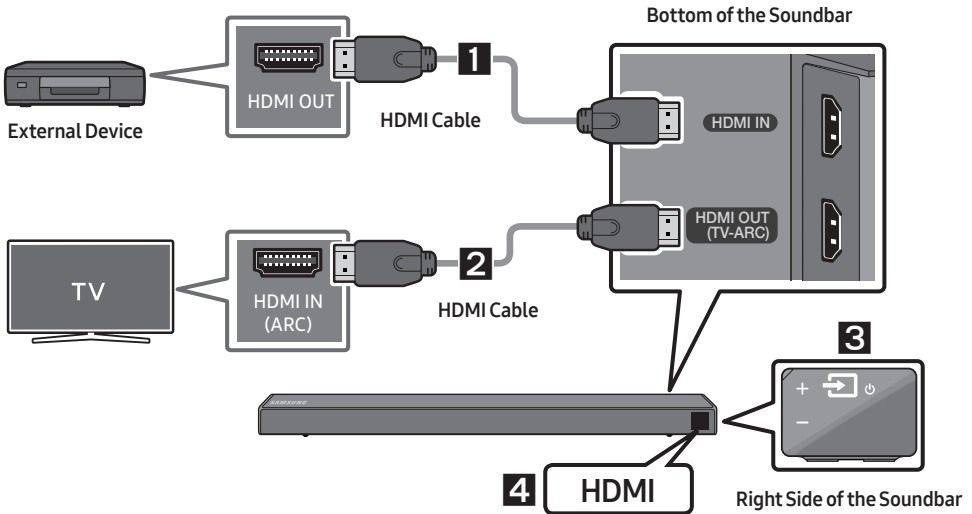

1. Connect an HDMI cable from the **HDMI IN** jack on the back of the product to the HDMI OUT jack on your digital device.
2. Connect an HDMI cable from the **HDMI OUT (TV-ARC)** jack on the back of the product to the HDMI IN jack on your TV.
3. Press the **Source** button on the right side panel or on the remote control, and then select "HDMI".
4. "HDMI" mode is displayed on the Soundbar display panel and sound plays.

Connecting using an Optical or Analogue Audio (AUX) Cable

BD / DVD player / Set-top box /
Game console

Right Side of the Soundbar

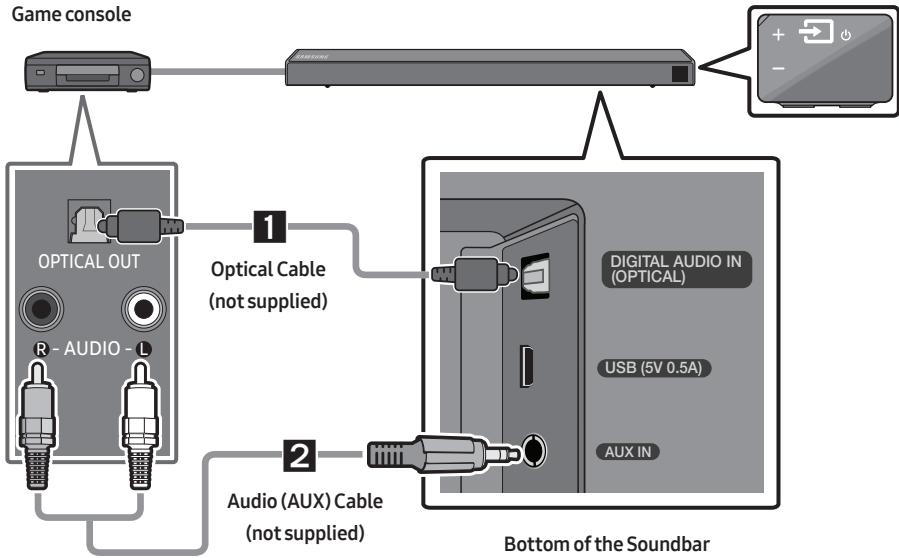

1 Optical Cable

- 1 Connect **DIGITAL AUDIO IN (OPTICAL)** on the main unit to the **OPTICAL OUT** jack of the Source Device using a digital optical cable (not supplied).
- 2 Select "**D.IN**" mode by pressing the  (**Source**) button on the right side panel or on the remote control.

2 Audio (AUX) Cable

- 1 Connect **AUX IN** (Audio) on the main unit to the **AUDIO OUT** jack of the Source Device using an audio cable.
- 2 Select "**AUX**" mode by pressing the  (**Source**) button on the right side panel or on the remote control.

06 CONNECTING A USB STORAGE DEVICE

You can play music files located on USB storage devices through the Soundbar.

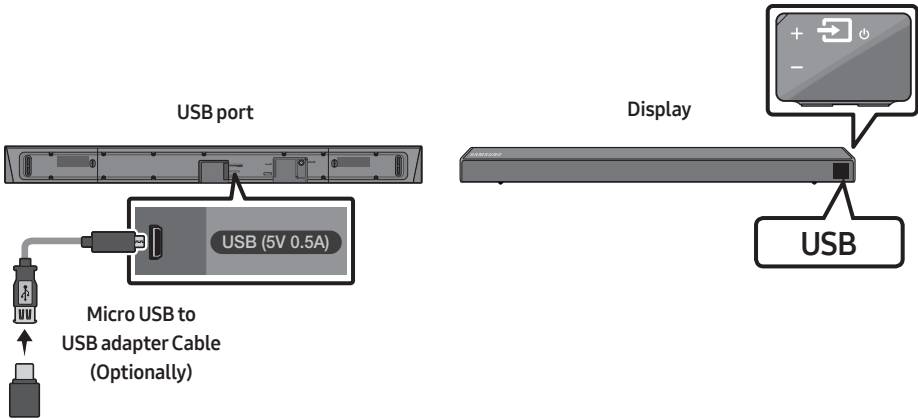

1. Connect a Micro USB to USB adapter cable with a male USB 2.0 Micro USB plug (Type B) on one end and a standard female 2.0 USB jack (Type A) on the other end to the micro USB jack on your Soundbar.
 - The Micro USB to USB adapter cable is sold separately. To purchase, contact a Samsung Service Centre or Samsung Customer Care.
2. Connect your USB device to the female end of the adapter cable.
3. Press the  (**Source**) button on the right side panel or on the remote control, and then select “USB”.
4. “USB” appears in the display screen.
5. Play music files from the USB storage device through the Soundbar.
 - The Soundbar automatically turns off (Auto Power Down) if no USB device has been connected for more than 20 minutes.

Software Update

Samsung may offer updates for the Soundbar’s system firmware in the future.

If an update is offered, you can update the firmware by connecting a USB device with the firmware update stored on it to the USB port on your Soundbar. For more information about how to download update files, go to the Samsung Electronics website at www.samsung.com → Support.

Then, enter or select the model number of your Soundbar, select the Software & Apps option, and then Downloads. Note that the option names can vary.

07 CONNECTING A MOBILE DEVICE

Connecting via Bluetooth

When a mobile device is connected using Bluetooth, you can hear stereo sound without the hassle of cabling.

- You cannot connect more than one Bluetooth device at a time.

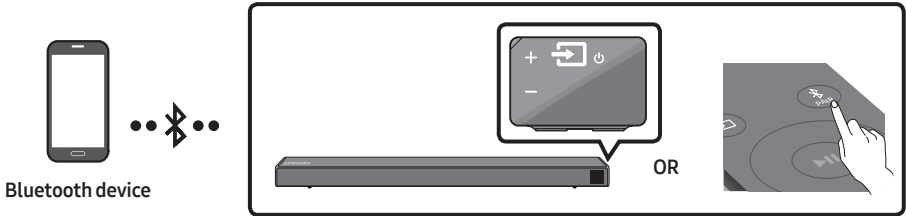

The initial connection

1. Press the **PAIR** button on the remote control to enter the “**BT PAIRING**” mode.
(OR) a. Press the **(Source)** button on the right side panel and then select “**BT**”.
“**BT**” changes to “**BT READY**” in a few seconds automatically if there is no Bluetooth device connected to the Soundbar.
b. When “**BT READY**” appears, press and hold the **(Source)** button on the right side panel of the Soundbar for more than 5 seconds to display “**BT PAIRING**”.
2. On your device, select “[**AV**] Samsung Soundbar R6-Series” from the list that appears.
 - When the Soundbar is connected to the Bluetooth device, [**Bluetooth Device Name**] → “**BT**” appears in the front display.
3. Play music files from the device connected via Bluetooth through the Soundbar.

If the device fails to connect

- If a previously connected Soundbar listing (e.g. “[**AV**] Samsung Soundbar R6-Series”) appears in the list, delete it.
- Then repeat steps 1 and 2.

NOTE





- After you have connected the Soundbar to your mobile device the first time, use the “**BT READY**” mode to reconnect. See Page 12 for details.



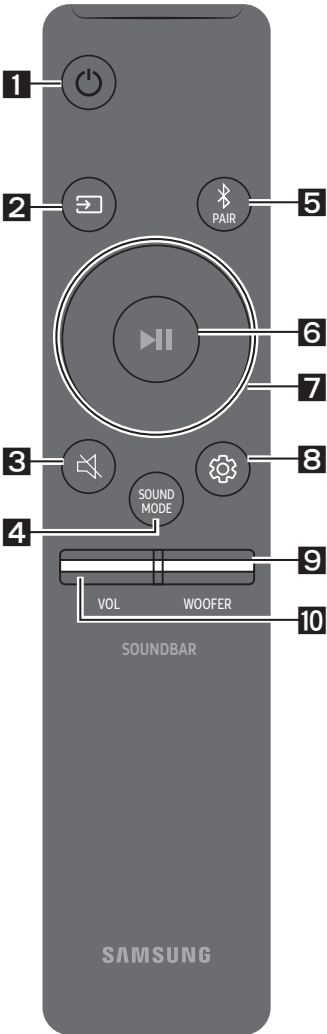



For more information about Bluetooth connections, refer to “Connecting a TV via Bluetooth” on pages 11 ~ 12.





08 USING THE REMOTE CONTROL

How to Use the Remote Control

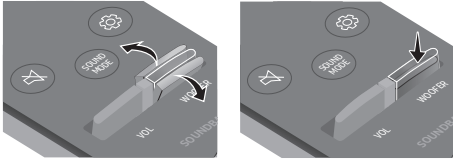

<p>1</p>	 Power	<p>Turns the Soundbar on and off.</p>
<p>2</p>	 Source	<p>Press to select a source connected to the Soundbar.</p>
<p>3</p>	 Mute	<p>Press the  (Mute) button to mute the sound. Press it again to unmute the sound.</p>
<p>4</p>	 SOUND MODE	<p>You can select the desired sound effect by choosing STANDARD, SURROUND SOUND, GAME, or SMART. Select the “STANDARD” mode if you want to enjoy the original sound.</p> <ul style="list-style-type: none"> DRC (Dynamic Range Control) Lets you apply dynamic range control to Dolby Digital tracks. Press and hold the SOUND MODE button while the Soundbar is powered off to turn DRC (Dynamic Range Control) on or off. With the DRC turned on, loud sound is reduced. (The sound may be distorted.) Bluetooth Power This feature automatically turns the Soundbar on when it receives a connection request from a previously connected TV or Bluetooth device. The setting is On by default. <ul style="list-style-type: none"> Press and hold the SOUND MODE button for more than 5 seconds to turn off the Bluetooth Power function.

<p>5</p>  <p>Bluetooth PAIR</p>	<p>Press the  PAIR button. "BT PAIRING" appears in the Soundbar's display. You can connect the Soundbar to a new Bluetooth device in this mode by selecting the Soundbar from the Bluetooth device's search list.</p>
<p>6</p>  <p>Play / Pause</p>	<p>Press the  button to pause a music file temporarily. When you press the button again, the music file plays.</p>
<p>7</p>  <p>Up/Down/ Left/Right</p>	 <p>Press the indicated areas to select Up/Down/Left/Right.</p> <p>Press Up/Down/Left/Right on the button to select or set functions.</p> <ul style="list-style-type: none"> • Repeat To use the Repeat function in "USB" mode, press the Up button. • Music Skip Press the Right button to select the next music file. Press the Left button to select the previous music file. • Anynet+ / Auto Power Link You can turn Anynet+ and Auto Power Link on or off. Anynet+ and Auto Power Link are turned on and turned off by the Right and Left buttons respectively. <ul style="list-style-type: none"> – Anynet+ : If the Soundbar is connected to a Samsung TV through an HDMI cable, you can control your Soundbar with a Samsung TV remote control. Press and hold the Right button for 5 seconds to toggle Anynet+ ON and OFF. – Auto Power Link : If the Soundbar is connected to your TV through a digital optical cable, the Soundbar can automatically turn on when you turn on your TV. Press and hold the Left button for 5 seconds to toggle Auto Power Link ON and OFF. – Anynet+ / Auto Power Link are set to ON by default. • ID SET Press and hold the Up button for 5 seconds to complete ID SET (when connecting to an accessory item).

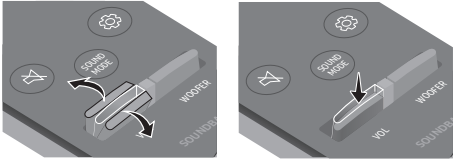
<p>8</p>	 <p>Sound Control</p>	<p>You can select TREBLE, BASS, or AUDIO SYNC.</p> <ul style="list-style-type: none"> To control the volume of the treble or bass sound, select TREBLE or BASS in Sound Settings, and then adjust the volume between -6~+6 by using the Up/Down buttons. If the video on the TV and audio from the Soundbar are not synchronised, select AUDIO SYNC in Sound Settings, and then set the audio delay between 0~300 milliseconds by using the Up/Down buttons. (Not available in "USB" mode.) AUDIO SYNC is only supported for some functions.
<p>9</p>	 <p>WOOFER</p>	 <p>Push the button up or down to adjust the volume of the subwoofer to -12 or between -6 to +6. To set the subwoofer volume level to 0, press the button.</p>
<p>10</p>	 <p>VOL</p>	 <p>Push the button up or down to adjust the volume.</p> <ul style="list-style-type: none"> Mute Press the VOL button to mute the sound. Press it again to unmute the sound.

Adjusting the Soundbar volume with a TV remote control

If you have a Samsung TV, you can adjust the Soundbar's volume using the IR remote control that came with your Samsung TV.

First use the TV menu to set the TV audio on your Samsung TV to external speakers, then use your Samsung remote to control the Soundbar's volume. For more information, see the TV's user manual. The default mode for this function is control by a Samsung TV remote. If your TV is not a Samsung TV, follow the directions below to change the settings of this function.

1. Turn Off the Soundbar.

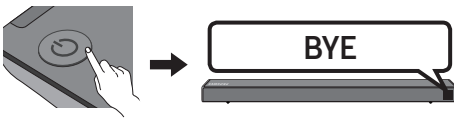

2. If you do not want to use this function, push up and hold the **WOOFER** button for 5 seconds repeatedly until **"OFF-TV REMOTE"** appears in the display.

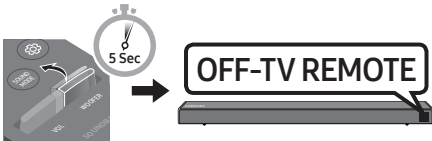

3. If you want to control the Soundbar with your TV's remote, push up and hold the **WOOFER** button for 5 seconds repeatedly until **"ALL-TV REMOTE"** appears in the display. Then, use your TV's menu to select external speakers.

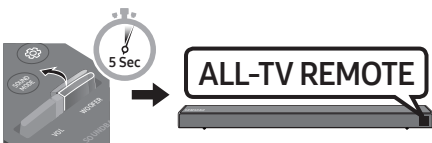

4. If you want to return the Soundbar to the default mode (control by a Samsung TV remote), push up and hold the **WOOFER** button for 5 seconds repeatedly until **"SAMSUNG-TV REMOTE"** appears in the display.

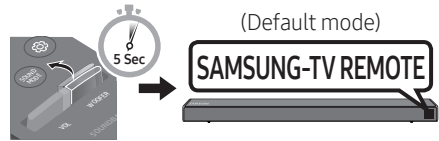

- Each time you push the **WOOFER** button up and hold it for 5 seconds, the mode switches in the following order: **"SAMSUNG-TV REMOTE"** (Default mode) → **"OFF-TV REMOTE"** → **"ALL-TV REMOTE"**.
- This function may not be available, depending on the remote control.
- For manufacturers that support this feature, refer to the FULL MANUAL for your Soundbar on the Samsung web site (www.samsung.com/support).
- This volume control function works with IR TV remotes only. It does not work with Bluetooth TV remotes (remotes that require pairing).

09 INSTALLING THE WALL MOUNT

Installation Precautions

- Install on a vertical wall only.
- Do not install in a place with high temperature or humidity.
- Verify whether the wall is strong enough to support the product's weight. If not, reinforce the wall or choose another installation point.
- Purchase and use the fixing screws or anchors appropriate for the kind of wall you have (plaster board, iron board, wood, etc.). If possible, fix the support screws into wall studs.
- Purchase wall mounting screws according to the type and thickness of the wall you want to mount the Soundbar on.
 - Diameter: M5
 - Length: 35 mm or longer recommended.
- Connect cables from the unit to external devices before you install the Soundbar on the wall.
- Make sure the unit is turned off and unplugged before you install it. Otherwise, it may cause an electric shock.

Wallmount Components



Wall Mount Guide



Holder-Screw



Screw



Bracket-Wall Mount

1. Place the **Wall Mount Guide** against the wall surface.
 - The **Wall Mount Guide** must be level.
 - If your TV is mounted on the wall, install the Soundbar at least 5 cm below the TV.

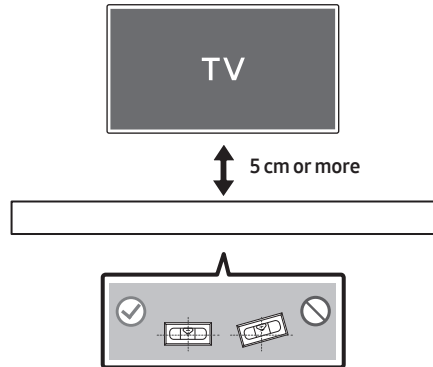

- Align the **Wall Mount Guide's Centre Line** with the centre of your TV (if you are mounting the Soundbar below your TV), and then fix the **Wall Mount Guide** to the wall using tape.
 - If you are not mounting below a TV, place the **Centre Line** in the centre of the installation area.

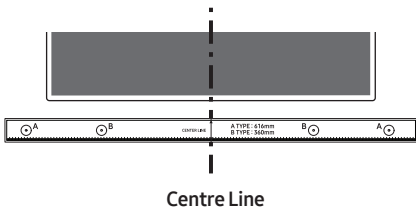

- Push a pen tip or sharpened pencil tip through the centre of the **A-TYPE** images on each end of the Guide to mark the holes for the supporting screws, and then remove the **Wall Mount Guide**.

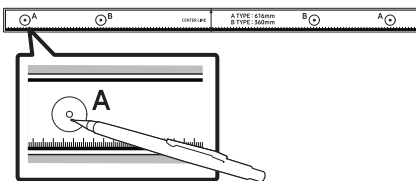

- Using an appropriately sized drill bit, drill a hole in the wall at each marking.
 - If the markings do not correspond to the positions of studs, make sure you insert appropriate anchors or mollys into the holes before you insert the support screws. If you use anchors or mollys, make sure the holes you drill are large enough for the anchors or mollys you use.

- Push a screw (not supplied) through each **Holder-Screw**, and then screw each screw firmly into a support screw hole.

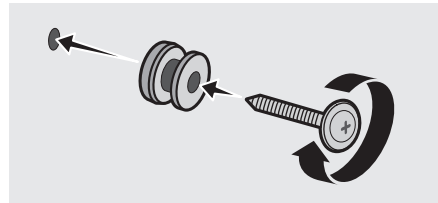

- Install the 2 **Bracket-Wall Mounts** in the correct orientation on the bottom of the Soundbar using 2 **Screws**.

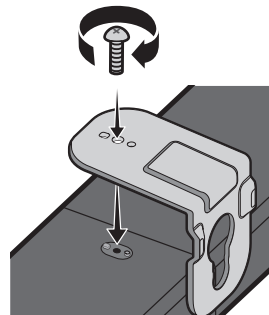

- When assembling, make sure the hanger part of the **Bracket-Wall Mounts** are located behind the rear of the Soundbar.

Rear of Soundbar

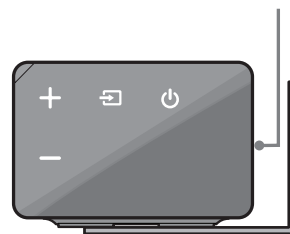

Right end of Soundbar

7. Install the Soundbar with the attached **Bracket-Wall Mounts** by hanging the **Bracket-Wall Mounts** on the **Holder-Screws** on the wall.

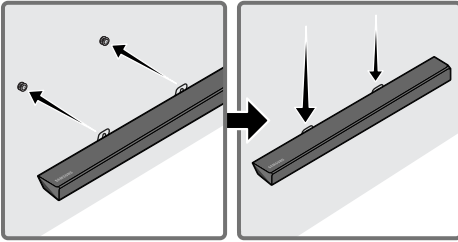

8. Slide the Soundbar down as shown below so that the **Bracket-Wall Mounts** rest securely on the **Holder-Screws**.
- Insert the **Holder-Screws** into the wide (bottom) part of the **Bracket-Wall Mounts**, and then slide the **Bracket-Wall Mounts** down so that the **Bracket-Wall Mounts** rest securely on the **Holder-Screws**.

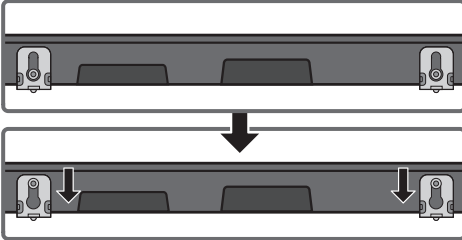

10 TROUBLESHOOTING

Before seeking assistance, check the following.

The unit will not turn on.

Is the power cord plugged into the outlet?

- Connect the power plug to the outlet.

A function does not work when the button is pressed.

Is there static electricity in the air?

- Disconnect the power plug and connect it again.

Sound dropouts occur in BT mode.

- See the Bluetooth connection sections on pages 11 and 16.

Sound is not produced.

Is the Mute function on?

- Press the **VOL** button to cancel the function.

Is the volume set to minimum?

- Adjust the Volume.

The remote control does not work.

Are the batteries drained?

- Replace with new batteries.

Is the distance between the remote control and Soundbar main unit too far?

- Move the remote control closer to the Soundbar main unit.

The red LED on the subwoofer blinks and the subwoofer is not producing sound.

This issue can occur if the subwoofer is not connected to the Soundbar main unit.

- Try to connect your subwoofer again. (See page 5.)

The subwoofer drones and vibrates noticeably.

Try to adjust the vibration of your subwoofer.

- Push the **WOOFER** button on your remote control up or down to adjust the subwoofer volume. (to -12, or between -6 ~ +6).

11 LICENCE



Manufactured under license from Dolby Laboratories. Dolby, Dolby Audio, Pro Logic, and the double-D symbol are trademarks of Dolby Laboratories.



For DTS patents, see <http://patents.dts.com>. Manufactured under license from DTS Licensing Limited. DTS, the Symbol, DTS in combination with the Symbol, and DTS Digital Surround are registered trademarks or trademarks of DTS, Inc. in the United States and/or other countries. © DTS, Inc. All Rights Reserved.



The terms HDMI and HDMI High-Definition Multimedia Interface, and the HDMI Logo are trademarks or registered trademarks of HDMI Licensing LLC in the United States and other countries.

12 OPEN SOURCE LICENCE NOTICE

To send inquiries and requests regarding open sources, contact Samsung via Email (oss.request@samsung.com).

13 IMPORTANT NOTES ABOUT SERVICE

Figures and illustrations in this User Manual are provided for reference only and may differ from actual product appearance.

14 SPECIFICATIONS AND GUIDE

Specifications

Model Name	HW-R650
USB	5V/0.5A
Weight	2.9 kg
Dimensions (W x H x D)	1060.0 x 59.0 x 87.5 mm
Operating Temperature Range	+5°C to +35°C
Operating Humidity Range	10 % ~ 75 %
AMPLIFIER Rated Output power	30W x 6
Supported play formats	LPCM 2ch, Dolby Audio™ (supporting Dolby® Digital), DTS

Subwoofer Name	PS-WR65D
Weight	6.0 kg
Dimensions (W x H x D)	200.0 x 353.0 x 302.0 mm
AMPLIFIER Rated Output power	160W

NOTES

- Samsung Electronics Co., Ltd reserves the right to change the specifications without notice.
- Weight and dimensions are approximate.
- **For India Only**
“This product is RoHS compliant”



© 2019 Samsung Electronics Co., Ltd. All rights reserved.

Contact SAMSUNG WORLD WIDE

If you have any questions or comments relating to Samsung products, please contact the SAMSUNG customer care Centre.

Area	Contact Centre ☎	Web Site
■ Asia Pacific		
CHINA	400-810-5858	www.samsung.com/cn/support
TAIWAN	0800-329-999	www.samsung.com/tw/support
HONG KONG	3698 4698	www.samsung.com/hk/support (Chinese)
MACAU	0800 333	www.samsung.com/hk_en/support (English)
SINGAPORE	1800 7267864 1800-SAMSUNG	www.samsung.com/sg/support
AUSTRALIA	1300 362 603	www.samsung.com/au/support
NEW ZEALAND	0800 726 786	www.samsung.com/nz/support
VIETNAM	1800 588 889	www.samsung.com/vn/support
THAILAND	0-2689-3232 (OTH products) 1800-29-3232 (Toll free)	www.samsung.com/th/support
MYANMAR	+95-1-2399-888	www.samsung.com/mm/support
CAMBODIA	+855-23-993232 1800-20-3232 (Toll free)	www.samsung.com/th/support
LAOS	+856-214-17333	
MALAYSIA	1800-88-9999 +603-7713 7420 (Overseas contact)	www.samsung.com/my/support
INDONESIA	021-5699-7777 0800-112-8888 (Toll Free)	www.samsung.com/id/support
PHILIPPINES	1-800-10-726-7864 [PLDT Toll Free] 1-800-8-726-7864 [Globe Landline and Mobile] 02-422-2111 [Standard Landline]	www.samsung.com/ph/support
INDIA	1800 40 SAMSUNG (1800 40 7267864) (Toll-Free)	
NEPAL	16600172667 (Toll Free for NTC Only) 9801572667	
BANGLADESH	09612300300 08000300300 (Toll free)	www.samsung.com/in/support
SRI LANKA	+9411SAMSUNG (+94117267864) +94117540540 +94115900000	

